



Circle Me If I'm Safe to Eat

Northern Ohio Poison Center
24 Hour Hotline
1-800-222-1222



Northern Ohio Poison Center



Color the things safe to eat and drink.
Put an X on the poisons.

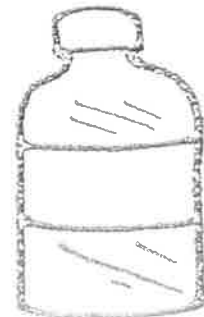
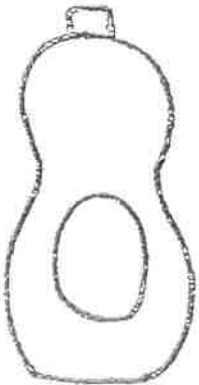
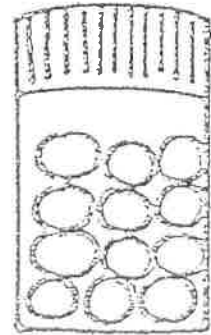
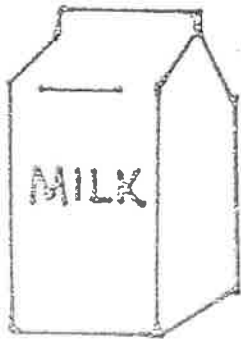
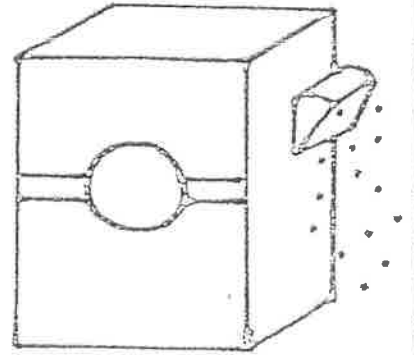
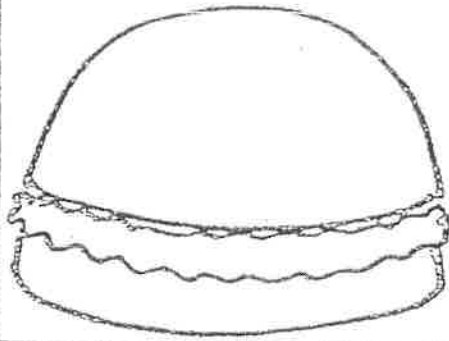
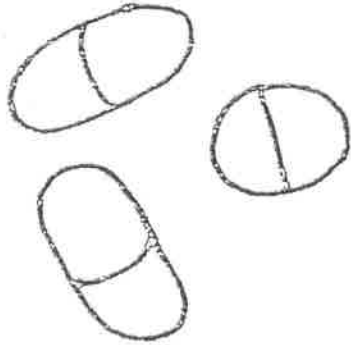

Stop and Think!

Never put anything in your mouth
that might not be safe to eat or drink!



Find the things that are NOT safe to eat or drink, color them red, along with the Stop sign. Then draw a line to connect these things to the Stop sign. Then color the rest of the picture any way you like.